

5. Fasikül "İ,i" sesi

Sesi Hissettirme
Sesi Tanıma
Ses Bileştirme
Yazı Çalışması
Kelime Türetme
Metin Oluşturma
Bulmaca



Adı:

Sesi Tanıyalım

Tarih: / /

Aşağıdaki resimlerdeki varlıkların adında "İ,i" sesi varsa yeşile "İ,i" sesi yoksa kırmızıya boyayalım.

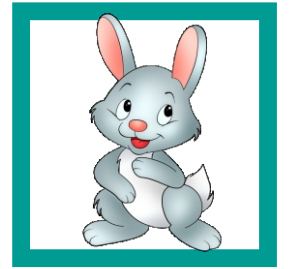
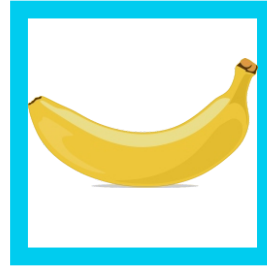
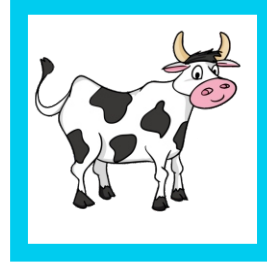

Kontrol Edildi
Öğretmen

Kontrol Edildi
Veli

Adı:

Sesi Tanıyalım

Tarih: / /

Resimlerdeki varlıkların adında "İ,i" baştaysa ilk daireyi, "İ,i" sesi ortadaysa ortadaki daireyi, "İ,i" sesi sonundaysa sondaki daireyi boyayalım.

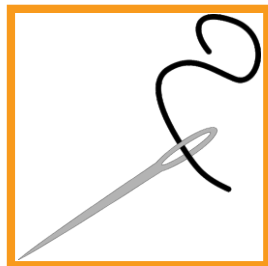
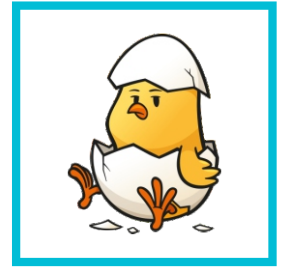

Kontrol Edildi
Öğretmen

Kontrol Edildi
Veli

Adı:

Sesi Yazalım

Tarih: / /

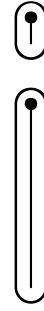

Tracing practice row for the letter 'i'. It contains 15 'i' characters on a yellow background with pink horizontal lines. The first 'i' is solid black, and the others are hollow for tracing.



Tracing practice row for the letter 'i'. It contains 15 'i' characters on a yellow background with pink horizontal lines. The first 'i' is solid black, and the others are hollow for tracing.



Tracing practice row for the letter 'i'. It contains 15 'i' characters on a yellow background with pink horizontal lines. The first 'i' is solid black, and the others are hollow for tracing.



Tracing practice row for the letter 'i'. It contains 15 'i' characters on a yellow background with pink horizontal lines. The first 'i' is solid black, and the others are hollow for tracing.



Tracing practice row for the letter 'ı'. It contains 15 'ı' characters on a yellow background with pink horizontal lines. The first 'ı' is solid black, and the others are hollow for tracing.



Tracing practice row for the letter 'ı'. It contains 15 'ı' characters on a yellow background with pink horizontal lines. The first 'ı' is solid black, and the others are hollow for tracing.



Tracing practice row for the letter 'ı'. It contains 15 'ı' characters on a yellow background with pink horizontal lines. The first 'ı' is solid black, and the others are hollow for tracing.



Tracing practice row for the letter 'ı'. It contains 15 'ı' characters on a yellow background with pink horizontal lines. The first 'ı' is solid black, and the others are hollow for tracing.



Tracing practice row for the letter 'ı'. It contains 15 'ı' characters on a yellow background with pink horizontal lines. The first 'ı' is solid black, and the others are hollow for tracing.



Kontrol Edildi
Öğretmen

Kontrol Edildi
Veli

Adı:

Sesi Yazalım

Tarih: / /

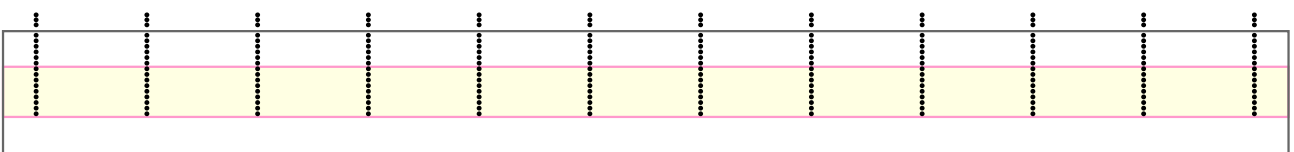
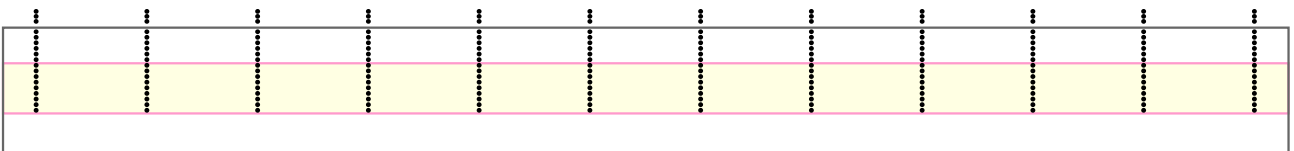
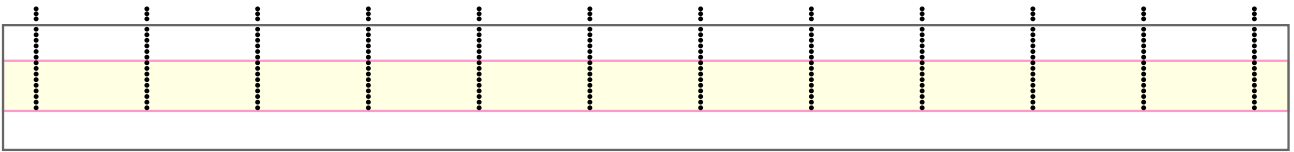
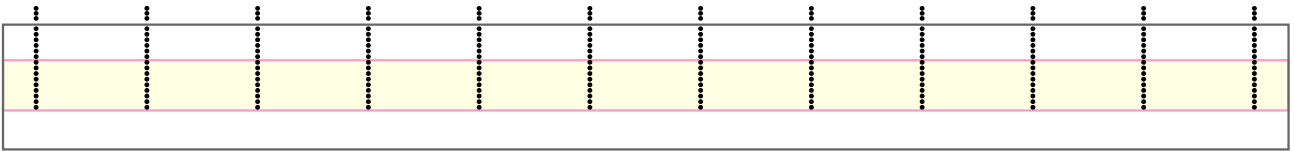
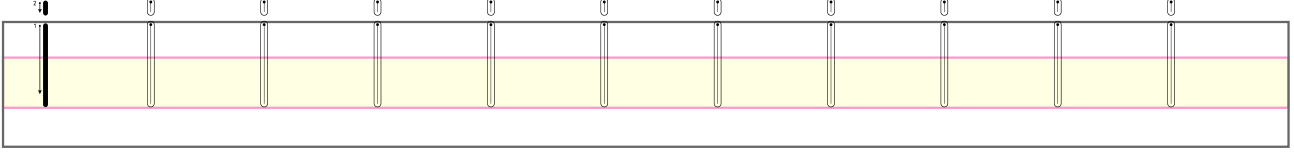
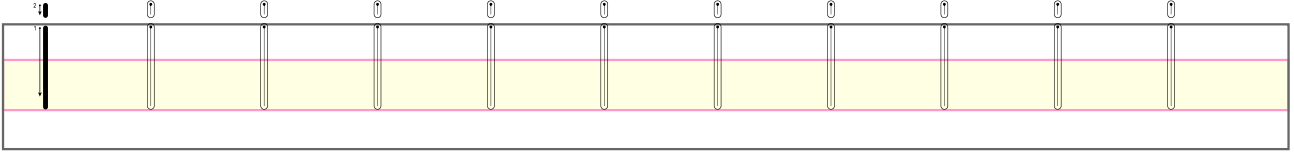
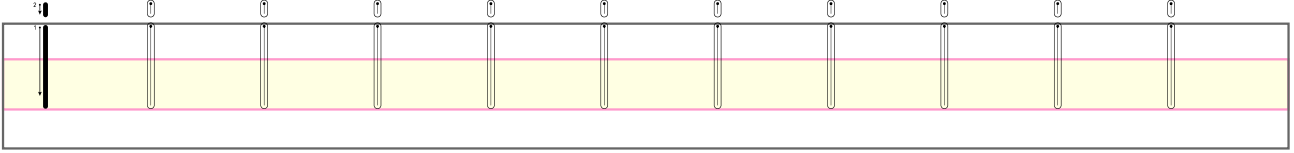
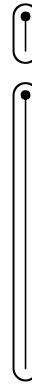

Kontrol Edildi
Öğretmen

Kontrol Edildi
Veli

Adı:

Sesi Yazalım

Tarih: / /

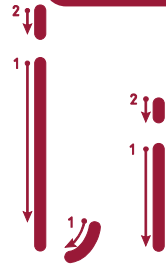

İ, i sesini takip ederek sineği incire ulaştıralım.



a	B	c	D	e	F	G	h	J	k	M	n	O	i	o
i	İ	i	İ	a	İ	i	İ	i	İ	i	D	A	İ	P
İ	Ö	Ç	i	V	i	U	t	S	r	İ	p	O	i	q
i	c	N	İ	T	İ	e	V	Ğ	x	i	Ü	A	İ	h
İ	Y	G	i	İ	i	t	r	s	Y	İ	i	İ	i	ü
i	Z	P	a	Y	R	v	R	s	z	u	G	o	h	Y
İ	b	E	R	s	T	u	V	ç	N	Y	z	b	C	q
i	C	R	M	a	L	k	J	y	d	F	M	n	j	R
İ	d	E	f	G	h	j	K	L	m	N	o	B	K	E
i	j	i	İ	i	A	b	C	d	z	E	P	d	e	H
İ	A	İ	B	İ	c	D	b	İ	i	İ	i	İ	M	b
i	j	i	c	i	m	N	o	i	R	d	s	i	n	A
İ	b	İ	D	İ	i	İ	i	İ	P	q	R	İ	O	r
i	İ	i	e	y	Z	b	C	s	T	h	t	i	p	S
F	G	h	J	k	M	n	O	İ	i	İ	i	İ	T	u



Kontrol Edildi
Öğretmen

Kontrol Edildi
Veli

Adı:

Sesleri Birleştirelim

Tarih:

i k ik

iklim



ik ik ik ik ik ik ik ik ik ik



ik ik ik ik ik ik ik ik ik ik



i il il

il



il il il il il il il il il il



il il il il il il il il il il



l i li

limon



li li li li li li li li li li



li li li li li li li li li li



k i ki

kitap



ki ki ki ki ki ki ki ki ki ki



Ki Ki Ki Ki Ki Ki Ki Ki Ki Ki



Kontrol Edildi
Öğretmen

Kontrol Edildi
Veli

Adı:

Sesleri Birleştirelim

Tarih: / /

A li

Ali Ali Ali Ali Ali Ali

Ali Ali Ali Ali Ali Ali



i ki

iki iki iki iki iki iki iki iki

iki iki iki iki iki iki iki iki

2

ki l

kil kil kil kil kil kil kil kil

kil kil kil kil kil kil kil kil



el i

eli eli eli eli eli eli eli eli

eli eli eli eli eli eli eli eli

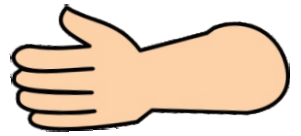

i le

ile ile ile ile ile ile ile ile

ile ile ile ile ile ile ile ile

Kontrol Edildi
Öğretmen

Kontrol Edildi
Veli

Adı:

Sesleri Birleştirelim

Tarih: / /

li la

lila lila lila lila lila lila lila

lila lila lila lila lila lila lila lila lila

el li

elli elli elli elli elli elli elli

elli elli elli elli elli elli elli

50

il ke

ilke ilke ilke ilke ilke ilke

ilke ilke ilke ilke ilke ilke



il la

illa illa illa illa illa illa illa

illa illa illa illa illa illa illa illa

ek li

ekli ekli ekli ekli ekli ekli

ekli ekli ekli ekli ekli ekli ekli

Kontrol Edildi
Öğretmen

Kontrol Edildi
Veli

Adı:

Sesleri Birleştirelim

Tarih: / /

a i le

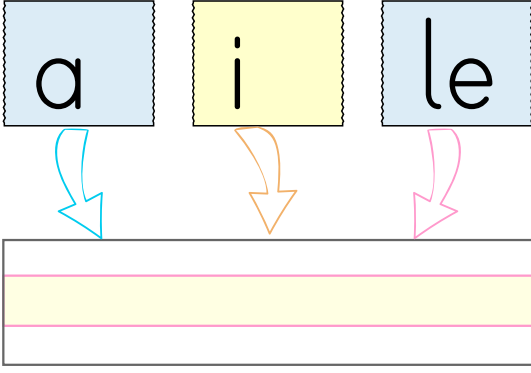

i lik le

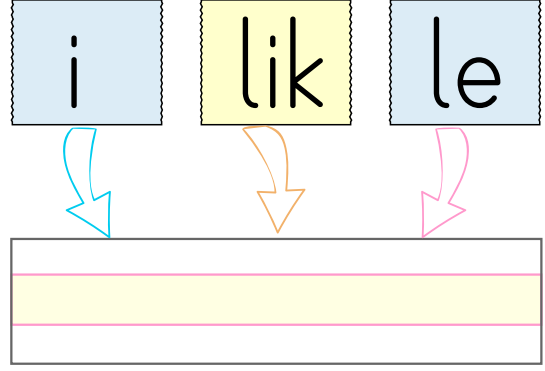

ka le li

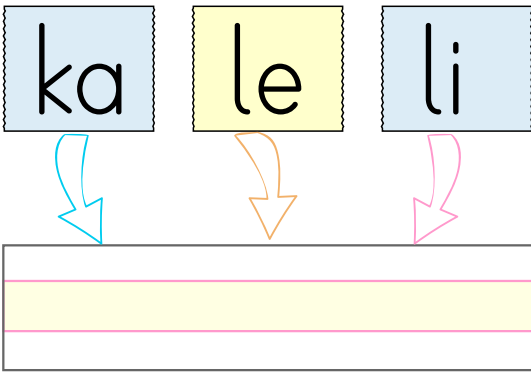

i ki li

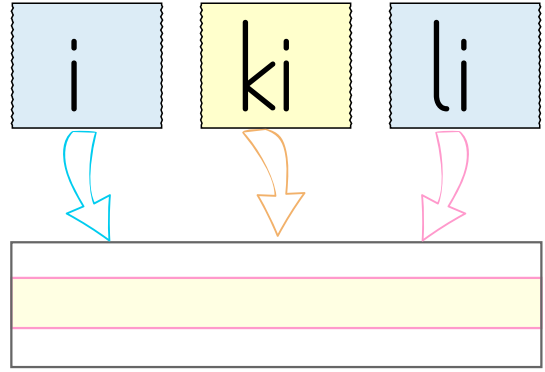

ke kik li

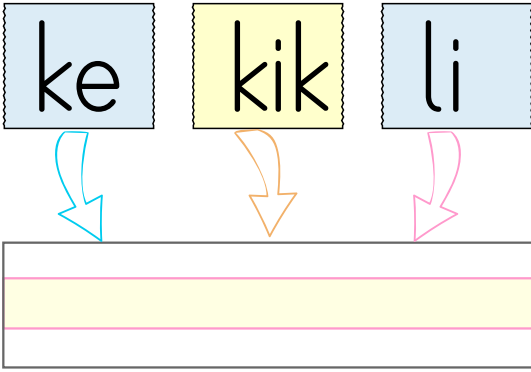

e ki li

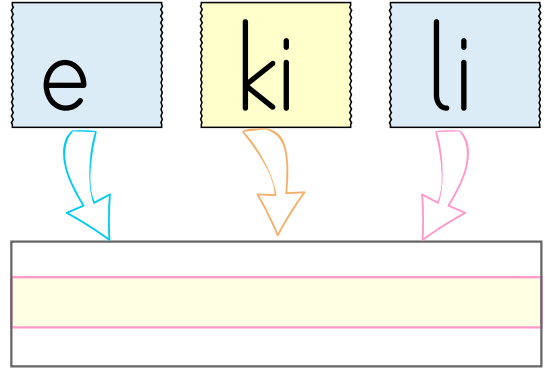

le ke li

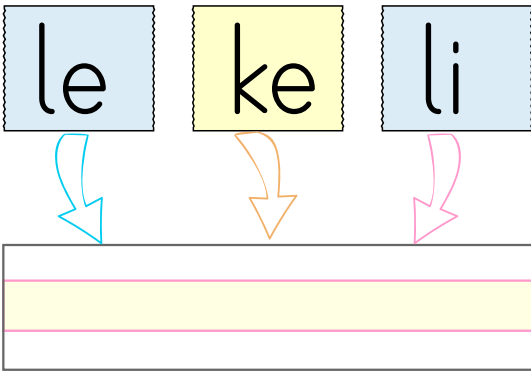

la le li

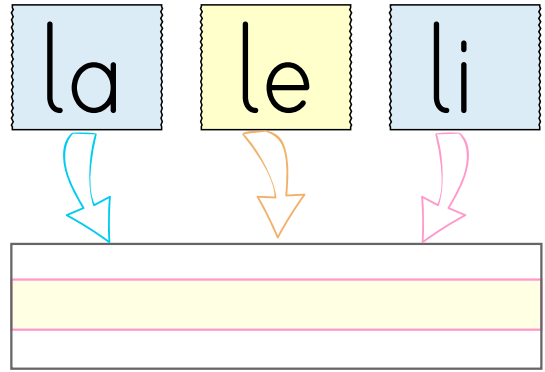

Kontrol Edildi
Öğretmen

Kontrol Edildi
Veli

Adı:

Metin Oluşturalım

Tarih: / /

Ali eli lale al.

Lale lila  al.

İlke eli kekik al.

Ela ile Ali aile.

Lale illa keki al.

Ela iki laleli  al.



Yukarıdaki cümleleri
5 defa okuyarak
aşağıdaki bölüme
yazalım.



Blank writing line for the first sentence.

Blank writing line with a red skirt icon in the center.

Blank writing line for the second sentence.

Blank writing line for the third sentence.

Blank writing line for the fourth sentence.

Blank writing line with a red skirt icon in the center.

Kontrol Edildi
Öğretmen

Kontrol Edildi
Veli

Adı:

Sesi Yazalım

Tarih: / /

Ali.

Ali al.

Ali kekik al.

Ali elli kekik al.

Ali elli iki kekik al.

Ali elli iki kekik al, elle.

Ali elli iki kekik al.

Ali elli kekik al.

Ali kekik al.

Ali al.

Ali.



Yukarıdaki hızlı okuma metnini
10 defa okuyup,
bakmadan deftere yazalım.

Kontrol Edildi
Öğretmen



Kontrol Edildi
Veli

Adı:

Sesi Yazalım

Tarih: .. / .. / ..

Aşağıdaki tabloda "İ,i" seslerini bulup yuvarlak içine alalım.

i	d	g	İ	A	e	b	h
d	p	İ	ö	h	k	i	r
i	r	g	h	İ	a	a	k
K	t	İ	u	A	ı	i	o
i	A	K		k	t	İ	
k	z	c		i	n	m	
m	a	İ	t	b	i	k	A
i	ö	ç	İ	a	K	ş	i
k	i	A	o	h	İ	e	K
y	l	İ	a	h	K	e	i

Kontrol Edildi
Öğretmen

Kontrol Edildi
Veli

Adı:

Sesi Yazalım

Tarih: / /

Çantaları Üzerindeki Harflere ve belirtilen renklere göre boyayalım.



Kontrol Edildi
Öğretmen

Kontrol Edildi
Veli

Adı:

Sesi Yazalım

Tarih: / /

Labirenti takip ederek ineği ota ulaştıralım.

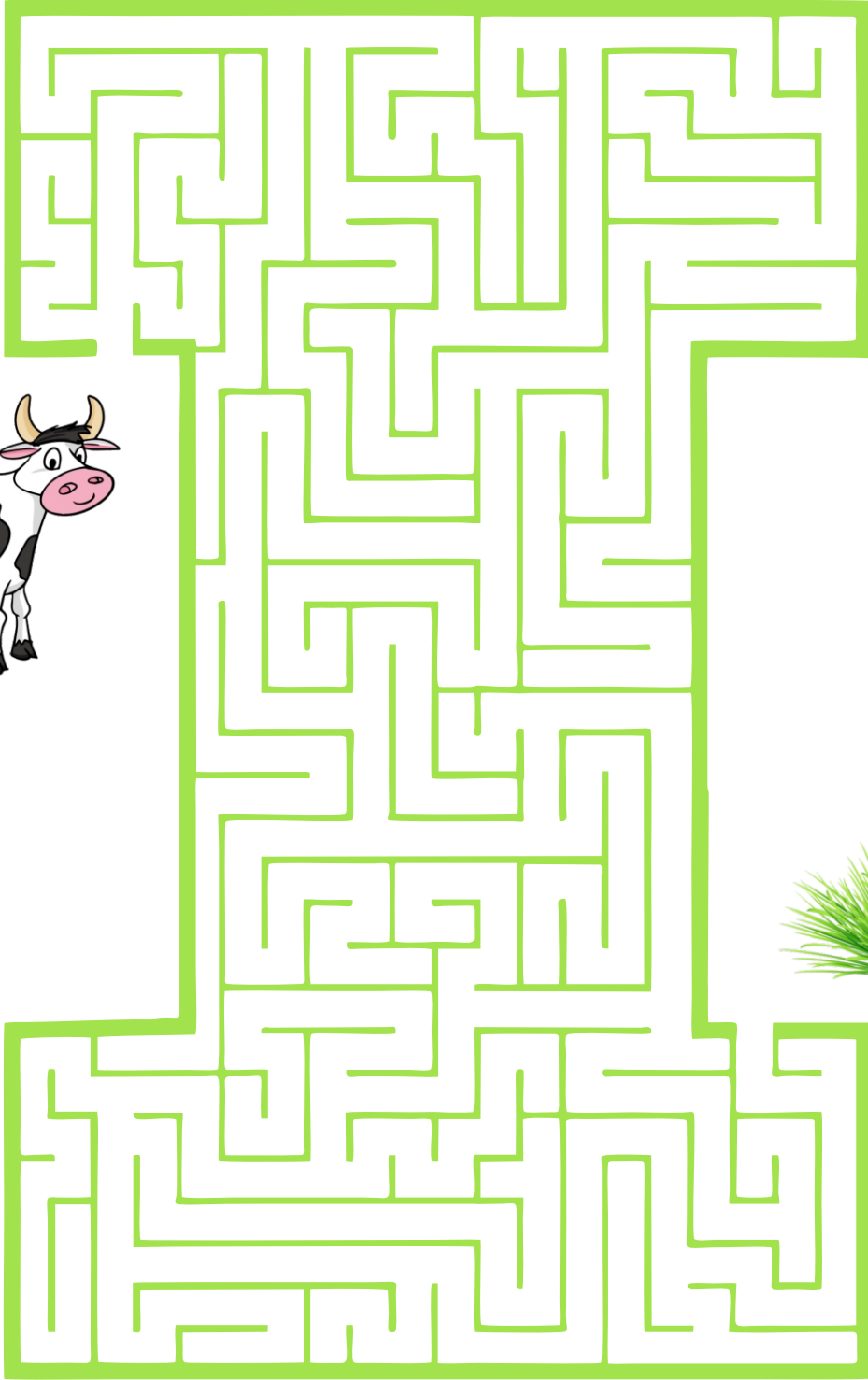
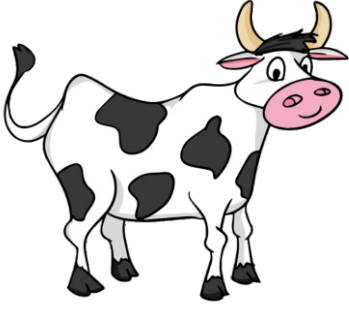
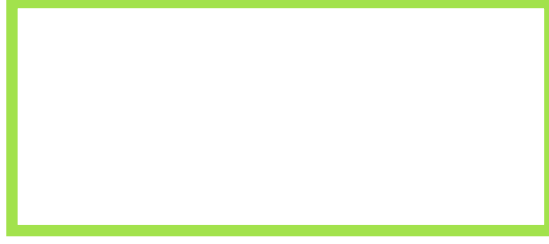

Kontrol Edildi
Öğretmen

Kontrol Edildi
Veli

Adı:

Eğlenelim

Tarih: / /

Aşağıdaki mandalayı aynı parçaları aynı renge boyamakla şartıyla boyayalım

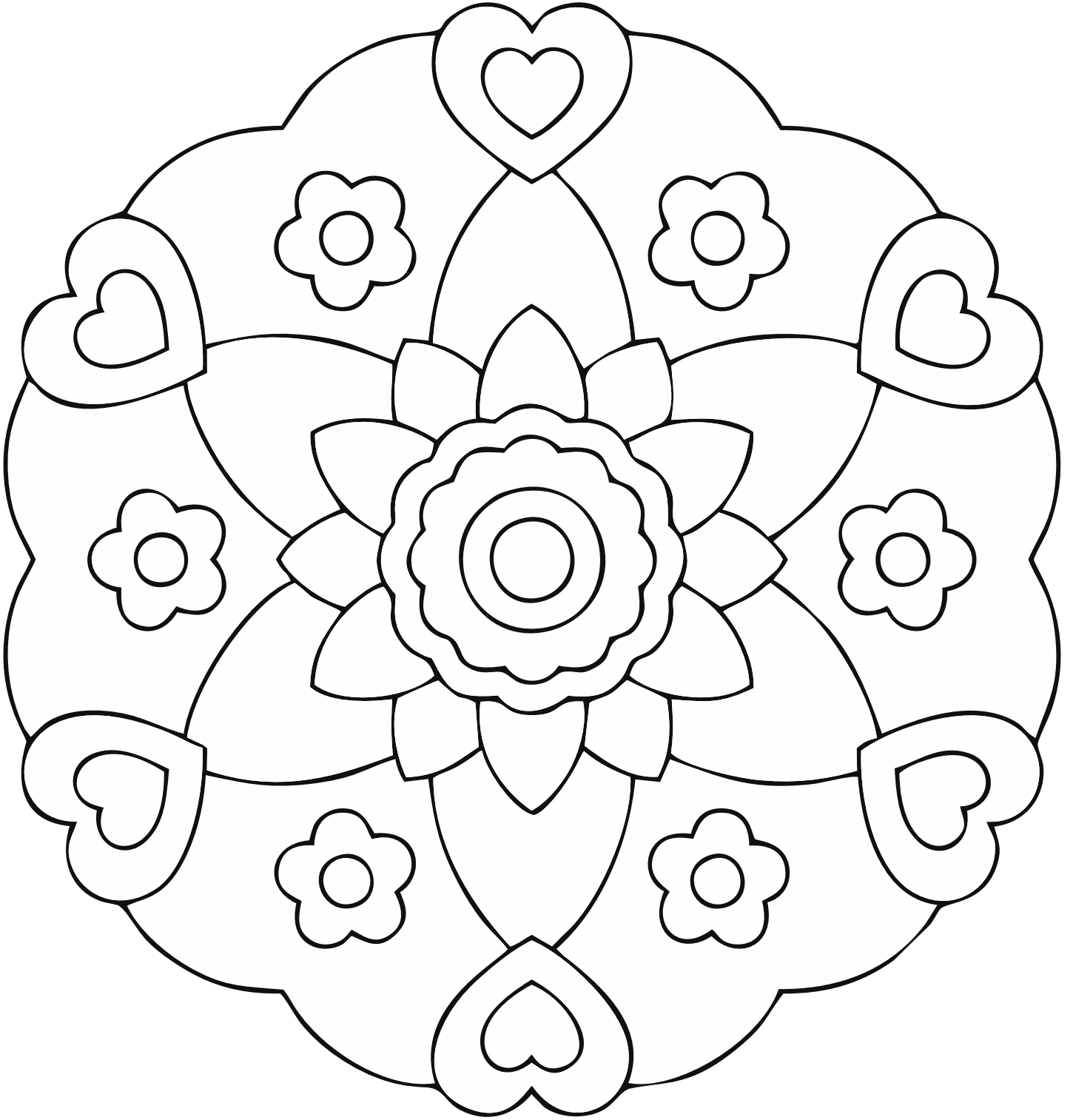

Kontrol Edildi
Öğretmen

Kontrol Edildi
Veli