





## HANGİ SESLE BAŞLAR – BOYA

		
d	b	p

		
d	b	p

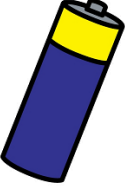
		
ş	ç	k

		
p	b	d

		
g	k	p

		
p	b	d

		
d	t	b

		
d	b	p

		
p	d	b

		
ç	s	ş

		
b	p	d

		
y	g	r

✚ İçinde P - p sesi bulunan daireleri boyayınız.

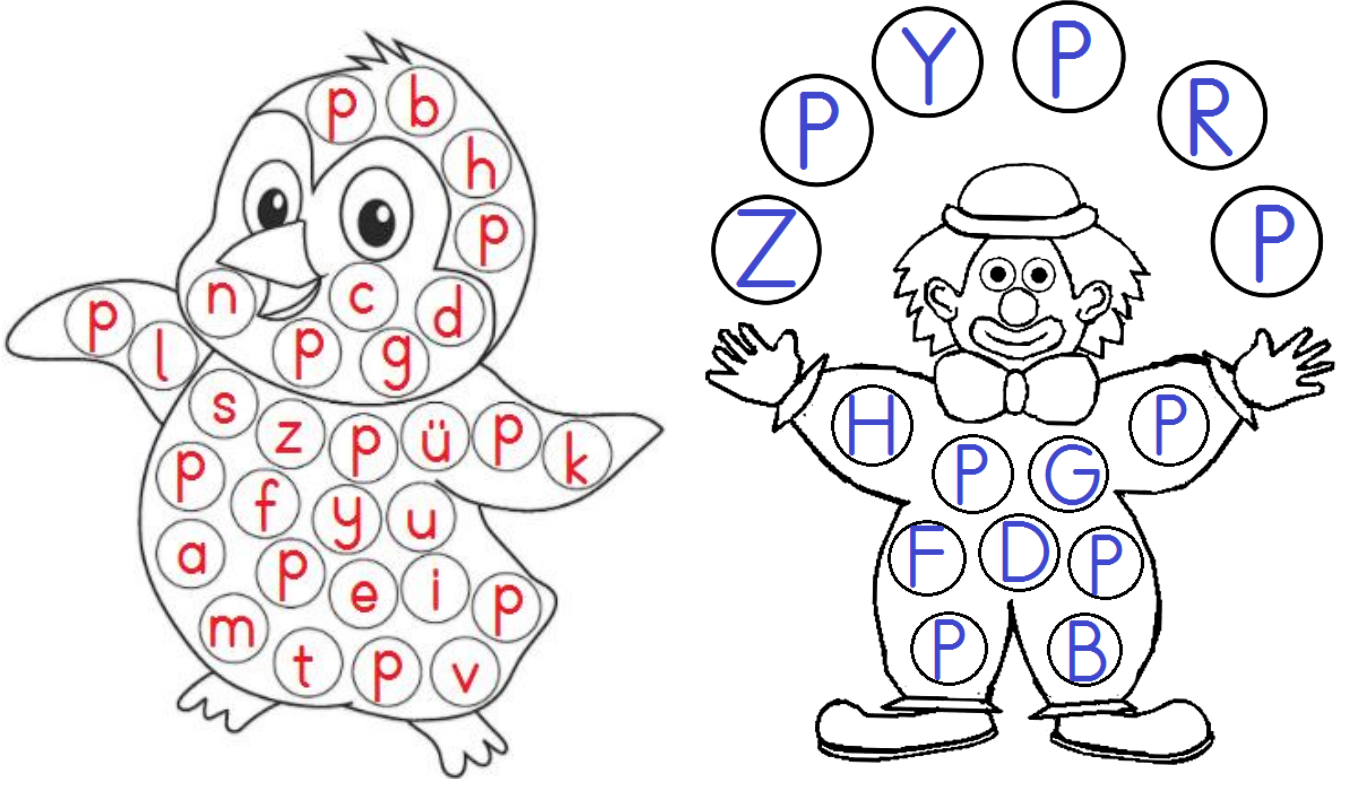

✚ Heceleri içeren pilleri istenen renklerle boyayınız.

pe	pa	pi	po	pu
Kırmızı	Sarı	Açık Mavi	Açık Yeşil	Kahverengi
pü	pö	pı	öp	ip
Pembe	Turuncu	Koyu Mavi	Mor	Koyu Yeşil

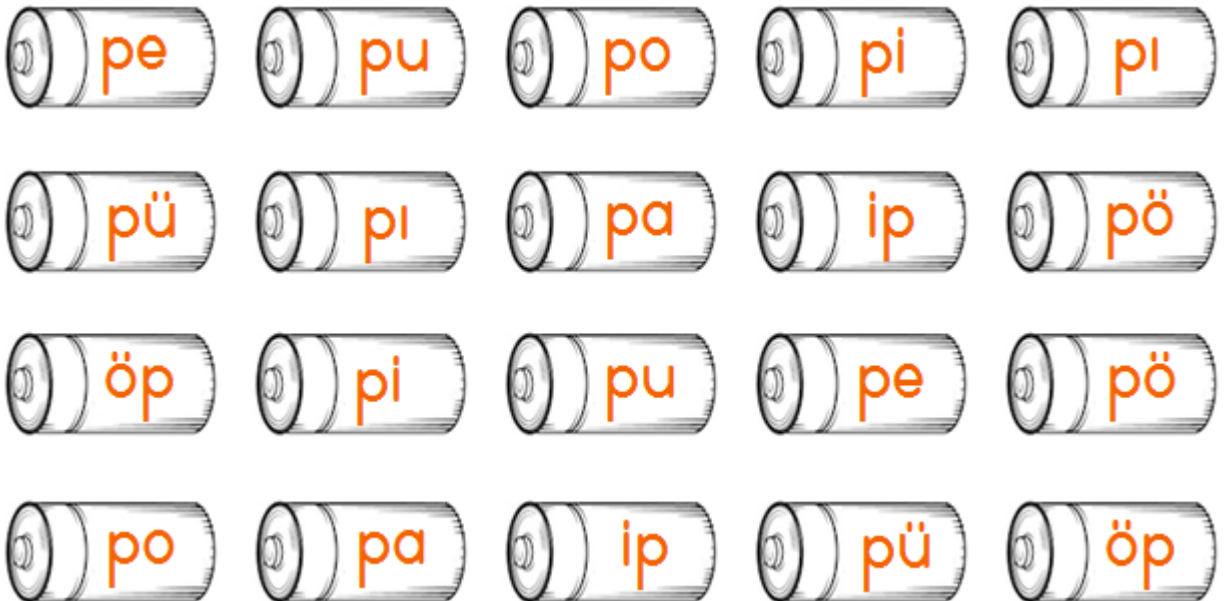

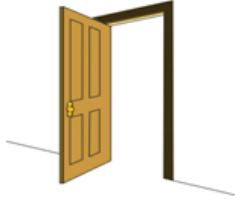

✚ Görseldeki varlığın ismini oluşturan, doğru heceleri boyayınız.

	
po	ta
pa	to

	
ga	pı
ka	bı

	
ba	ku
gu	pa

	
kü	be
pe	ki

	
rap	co
yap	ço

	
kir	gir
pi	bi

	
po	liz
bo	lis

	
pat	sa
se	pet

	
pek	bek
gö	kö

# OKU – EŞLEŞTİR



karpuz



çorap



piyano

deprem



panda



palyaço

kepçe



pil



köpek

kitap



yaprak



polis

top



OKU - KES - YAPIŞTIR



--	--	--	--



--	--	--	--



--	--	--	--

karpuz	yelpaze	kitap	patates
kalp	köprü	top	pasta
poşet	kelepçe	şapka	mektup

## EKSİK HARF TAMAMLAMA



t...p

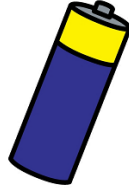

...il



kü...e



pri...



ip...ik



...armak



pikni...



ka...lan



pa...atya

# DOĞRUSUNU BUL – BOYA



tüp

kop

top



kati

kapı

kazı



yerde

karne

perde



pilot

pide

plan



paket

para

paten



köpük

köprü

köpek



pasta

panda

parke

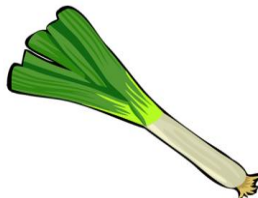

pirasa

patates

porsuk



pamuklu

pazartesi

palyaço

✚ Görselle ilgili olan cümlelerin kutusunu boyayınız.



Kasaptan pırzola aldım.  
Perdeleri poşete koydu.  
Dün akşam deprem oldu.



Karpuzun tadı pek güzel.  
Kitap okumak yararlıdır.  
Ablam piyano çalıyor.



Peynir yemek istiyorum.  
Ayılar petekten bal yer.  
Bilgili olmak için araştır.



Radyomun pili bitmiş.  
İp atlamak boy uzatır.  
Peker pop müzik dinler.



Annem papatya topladı.  
Turp ile patates aldım.  
Pınar pembe paten aldı.



✚ Cümleleri kesip ilgili görsellerin altına yapıştırınız.



Elini sabunla köpürt.

Kedi iple çok oynar.

Pelin piknik yaptı.

Çoraplar pis kokuyor.

Portakal suyu içtim.

Kıymalı pide yedim.

# OKU - SORULARI CEVAPLA



Postacı mektup getiriyor.

Ne getiriyor?



Sincap köprüden atladı.

Nereden atladı?



Daldan yaprak koparmadı.

Nereden koparmadı?



Polat buzda paten kaydı.

Kim kaydı?



Zeynep pandayı yakaladı.

Neyi yakaladı?



## P SESİ BULMACASI

kupon	parsel	rapor	yapay
pancar	ketçap	toprak	Pınar
sapan	toplum	çarpma	pekmez
Poyraz	kebab	panik	Eyüp

b	E	r	i	n	c	t	o	p	l	u	m	c	a
ö	y	a	p	a	y	l	k	e	g	e	r	E	ç
p	u	c	a	c	i	p	a	r	s	e	l	e	a
a	r	ş	i	n	ü	u	s	A	m	u	m	a	ş
n	s	a	p	a	n	P	ö	z	ç	y	k	a	C
i	e	e	ç	i	t	g	d	ö	a	e	e	d	r
k	p	e	k	m	e	z	ç	o	r	u	t	P	a
P	ü	z	B	s	A	t	i	c	p	k	ç	o	p
s	i	k	a	k	a	ü	M	g	m	z	a	y	o
P	E	u	g	E	y	ü	p	ö	a	c	p	r	r
i	c	p	e	t	r	a	e	z	i	ü	z	a	n
n	a	o	g	t	o	p	r	a	k	m	e	z	e
a	ş	n	a	z	ç	c	P	ü	l	l	k	z	r
r	a	k	e	b	a	p	a	p	a	n	c	a	r