

Adı : .....  
Soyadı: .....

1. Sınıf  
Okuma-Yazma

Ş - ş

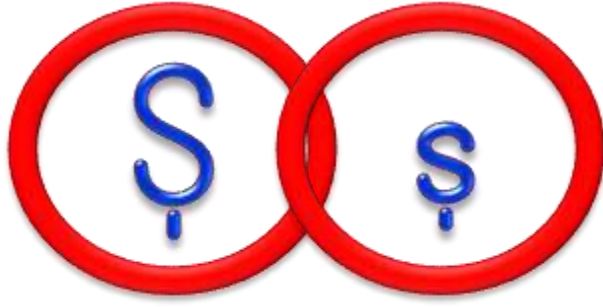

Aşağıdaki görsellerin isimlerini söyleyiniz.



İçinde Ş-ş sesi geçen görselleri işaretleyiniz.

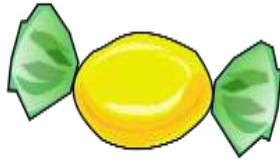

Adı : .....  
Soyadı: .....

1 . Sınıf  
Okuma-Yazma

Ş - ş

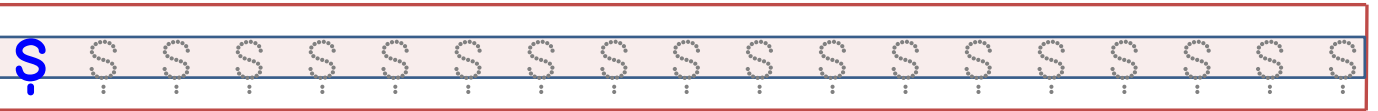
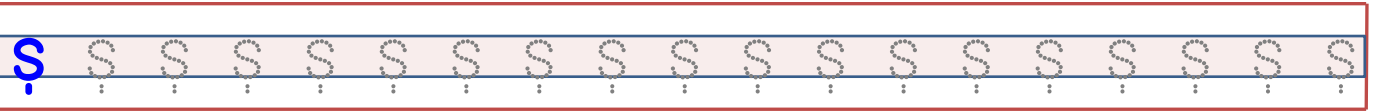
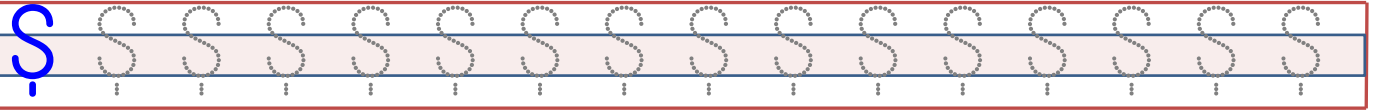
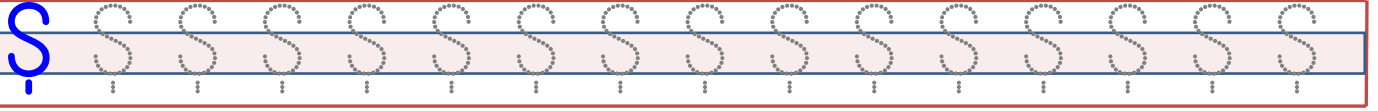

Adı : .....  
Soyadı: .....

1. Sınıf  
Okuma-Yazma

Ş - ş



Ş Ş Ş Ş Ş Ş Ş Ş Ş Ş Ş ş ş ş ş ş ş ş ş ş ş ş ş ş ş ş

Blank handwriting practice lines.

ş ş ş ş ş ş ş ş ş ş ş ş ş ş Ş Ş Ş Ş Ş Ş Ş Ş Ş Ş

Blank handwriting practice lines.

Ş Ş Ş Ş Ş ş

Blank handwriting practice lines.

Ş ş Ş ş Ş ş Ş ş Ş ş Ş ş Ş ş Ş ş

Blank handwriting practice lines.

Blank handwriting practice lines.

Adı : .....  
Soyadı: .....

1. Sınıf  
Okuma-Yazma

Ş - ş

aş

eş

ış

iş

oş

öş

uş

üş

şa

şe

şı

şi

şo

şö

şu

şü

şan

şak

şar

şek

şem

şez

şer

şık

şın

şıy

şıt

şiş

şim

şil

şor

şok

şot

şöz

şök

şöl

şöm

şut

şum

şük

şüm

şüç

şür

şüt

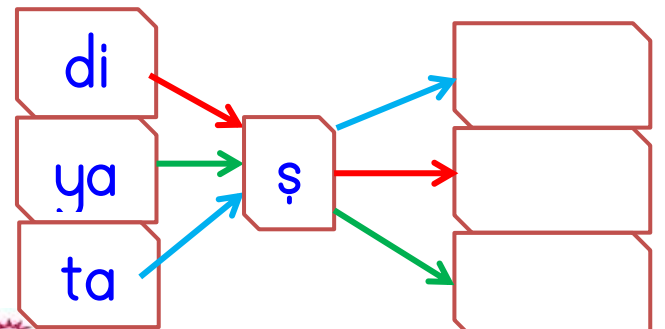
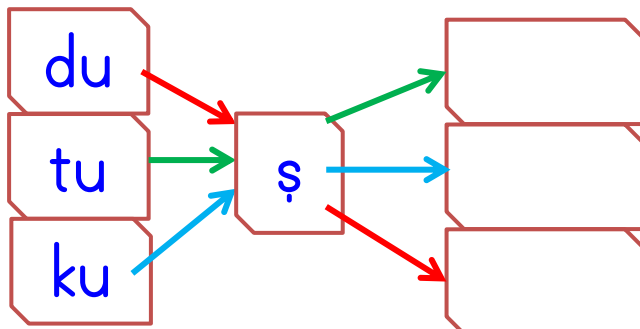
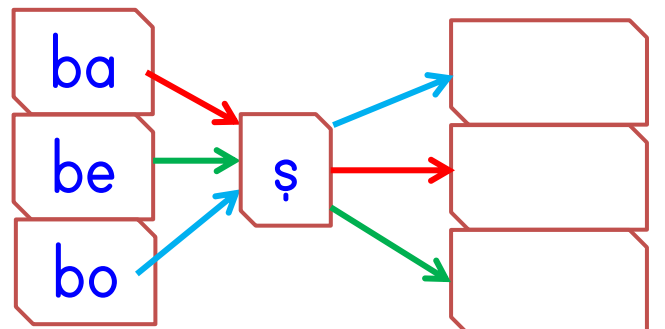
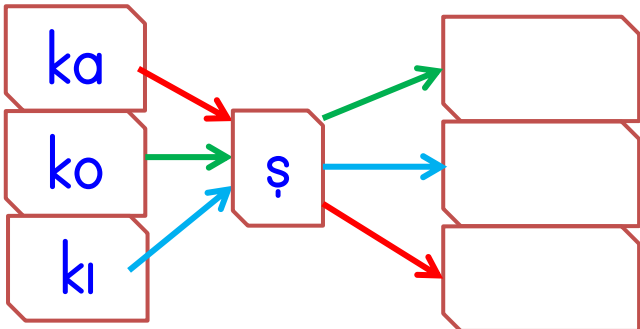

Adı : .....  
Soyadı: .....

1. Sınıf  
Okuma-Yazma

Ş - ş

şa

n

şı

k

ku

ş

ba

ş

ta

ş

şi

ir

şar

kı

şer

bet

kom

şu

gü

neş

dü

ş

gü

reş

şen

lik

Şu

le

Şe

nay

Şa

kir

be

ş

bo

ş

a

teş

tur

şu

al

kış

Şa

kir

Ay

şen

kar

deş

Adı : .....  
Soyadı: .....

1. Sınıf  
Okuma-Yazma

Ş - ş

ar ka daş

şem si ye

dı şa rı

çar şam ba

şö mi ne

iş kem be

gü neş lik

yu mu şak

muş mu la

şı rin ga

şe ker li

şiş man lık

ba şa rı

ba rış mak

ka rış mak

ça lış kan

Be şik taş

bi ti şik

Adı : .....  
Soyadı: .....

1. Sınıf  
Okuma-Yazma

Ş - ş



ŞİŞE



Şu köşe yaz köşesi.  
Şu köşe kış köşesi.  
Ortada su şişesi.  
Şırl şırl su akmış.  
Güneş başımı yakmış.  
Şule bu işe çok şaşırılmış.







Adı : .....  
Soyadı: .....

1. Sınıf  
Okuma-Yazma

Ş - ş

Şule şerbete şeker karıştırmış.

Çalışırsan başarılı olursun.

Şenay bu akşam muşmula yemiş.

Ayşe ile Şükrü arkadaş olmuşlar.

Şakir bize gelmiş, sonra işine gitmiş.



Adı : .....  
Soyadı: .....

1 . Sınıf  
Okuma-Yazma

Ş - ş

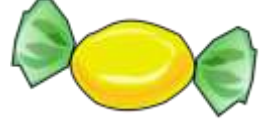

5

Adı : .....  
Soyadı: .....

1. Sınıf  
Okuma-Yazma

Ş - ş

## ŞEKER

Şenay koşarak bakkala gitmiş.  
Bakkaldan yeşil şekerlerden  
istemiş. Bakkal "Yeşil şeker yok."  
 demiş. Şenay beş şişe su istemiş.  
Bakal beş şişe suyu uzatmış.  
Şenay şişeleri almış, teşekkür  
etmiş. Şişeleri almış, bakkaldan  
koşarak çıkmış.

## MİNİK KUŞ

Kış gelmiş.  
Minik kuş üşümüştü.  
Daldan dala konmuş.  
Çeşmeye uçmuş.  
Su içmek istemiş.  
Ama su da donmuş.

## ÇÜRÜK DİŞ

Ayşe şeker yermiş.  
Beşer beşer yemiş.  
Dişlerini yıkamamış.  
Çürümüş tüm dişleri  
Annesi dişçiye götürmüştü.  
Dişçi tüm dişlerini çekmiş.

Adı : .....  
Soyadı: .....

1. Sınıf  
Okuma-Yazma

Ş - ş



## KURŞUNLU ŞELALESİ

Ben Şebnem. Şimdi kardeşimle ben Şanlıurfa'da yaşıyoruz. Antalya'da bulunan Kurşunlu Şelalesi çok ünlüymüş. Şelaleden sular şırl şırl akarmış. Dallarda çeşitli kuşlar neşeyle ötüşürmüştü. Şelalenin yanında yemyeşil bitkiler bulunurmuş. Bu yaz kardeşimle Kurşunlu Şelalesi'ne gitmeyi düşünüyoruz. Belki de dönüşte Düden Şelalesi'ne de gideriz.

Şebnem nerede yaşıyormuş?

Kurşunlu Şelalesi neredeymiş?

Adı : .....  
Soyadı: .....

1. Sınıf  
Okuma-Yazma

Ş - ş

Şelalenin yanında neler bulunurmuş?

Şebnem nereye gitmeyi düşünüyormuş?

Kurşunlu Şelalesi neredeymiş?



Ankara'da



Antalya'da



Bursa'da

Şelaleden sular nasıl akarmış?



Şırl şırl



Gürül gürül



İşil işil

Şelaledeki kuşlar nasıl ötüşürmüş?



güzel



neşeyle



mutlu

Şebnem kiminle gitmeyi düşünüyormuş?



Kardeşi ile



Arkadaşı ile



Ablası ile

Adı : .....  
Soyadı: .....

1. Sınıf  
Okuma-Yazma

Ş - ş

Antalya'daki Kurşunlu ..... çok ünlüymüş.



Deresi



Şelalesi



Gölü

Şelaleden ..... şırıl şırıl akarmış.



bitkiler



sular



kuşlar

Dallarda çeşitli kuşlar ..... ötüşürmüş.



neşeyle



güzel



mutlu

Şelalenin yanında yemyeşil ..... bulunurmuş.



sular



kuşlar



bitkiler

Bu yaz ..... gitmeyi düşünüyoruz.



kardeşimle



annemle



babamla

Belki de ..... Şelalesine de gideriz.



Kurşunlu



Düden



Uçansu

Adı : .....  
Soyadı: .....

1. Sınıf  
Okuma-Yazma

Ş - ş

D Y Şebnem Antalya'da yaşıyormuş.

D Y Kurşunlu Şelalesi Antalya'daymış.

D Y Kuşlar üzgün üzgün ötüşürmüş.

D Y Bitkiler yemyeşil olmuş.

D Y Şebnem, Düden Şelalesi'ne gitmiş.

D Y Kurşunlu Şelalesi çok ünlüymüş.

bakmış...

miş

gez.....

gör.....

miş

dön.....

bul.....

muş

al.....

bil.....

uç.....

sat.....

müş

gülmüş....

sus.....

gel.....