

N-n

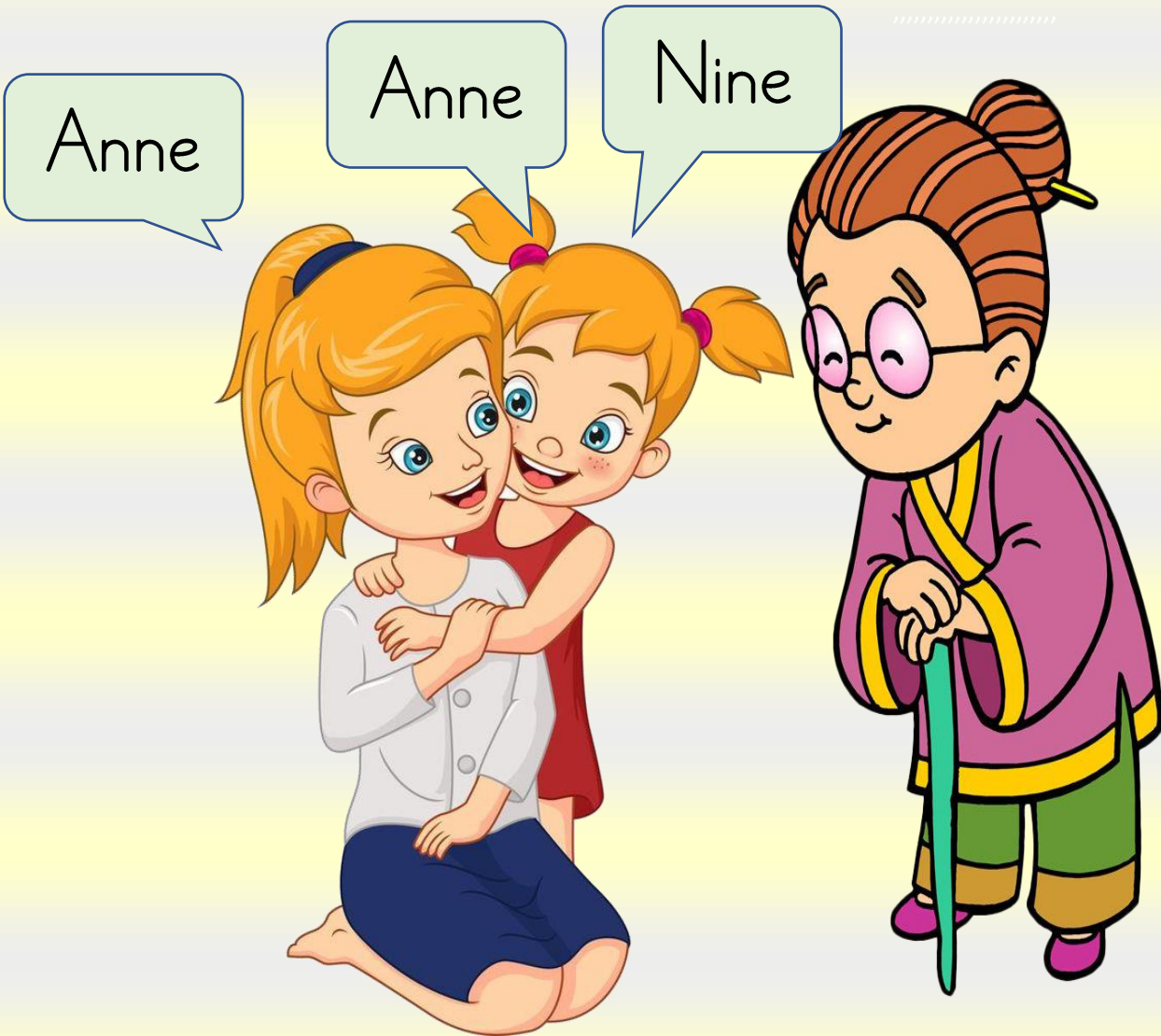

Adı:
Soyadı:

Türkçe
İlk Okuma ve Yazma

N Harfi

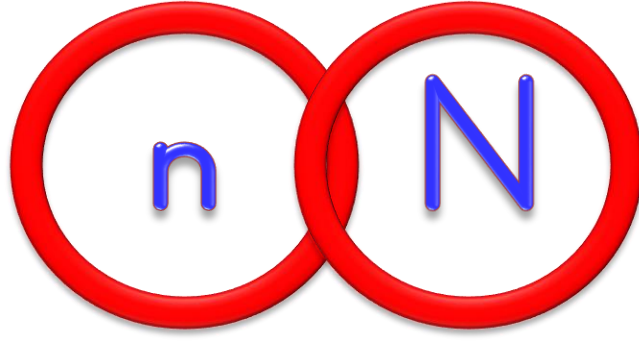

Aşağıdaki görsellerin isimlerini söyleyiniz.

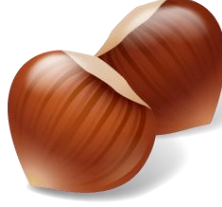

Aşağıdaki görsellerin isimlerini heceleyerek söyleyiniz. **İçinde n sesi geçen görselleri köpekbalığı ile birleştiriniz.**

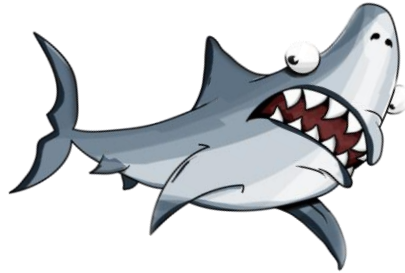

Aşağıdaki görsellerin isimlerini heceleyerek söyleyiniz. n sesi ile başlayan görselleri işaretleyelim.

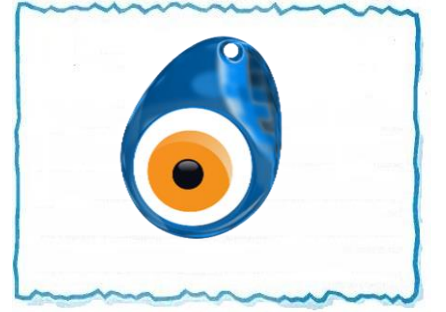
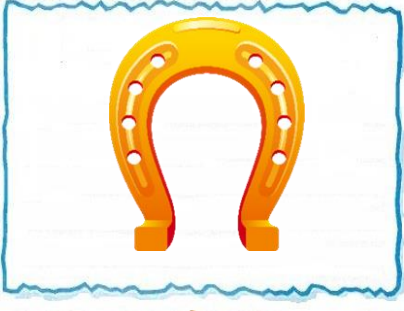

Aşağıdaki tablodaki sesleri okuyunuz. n-N harflerini bularak yuvarlak boyayınız.

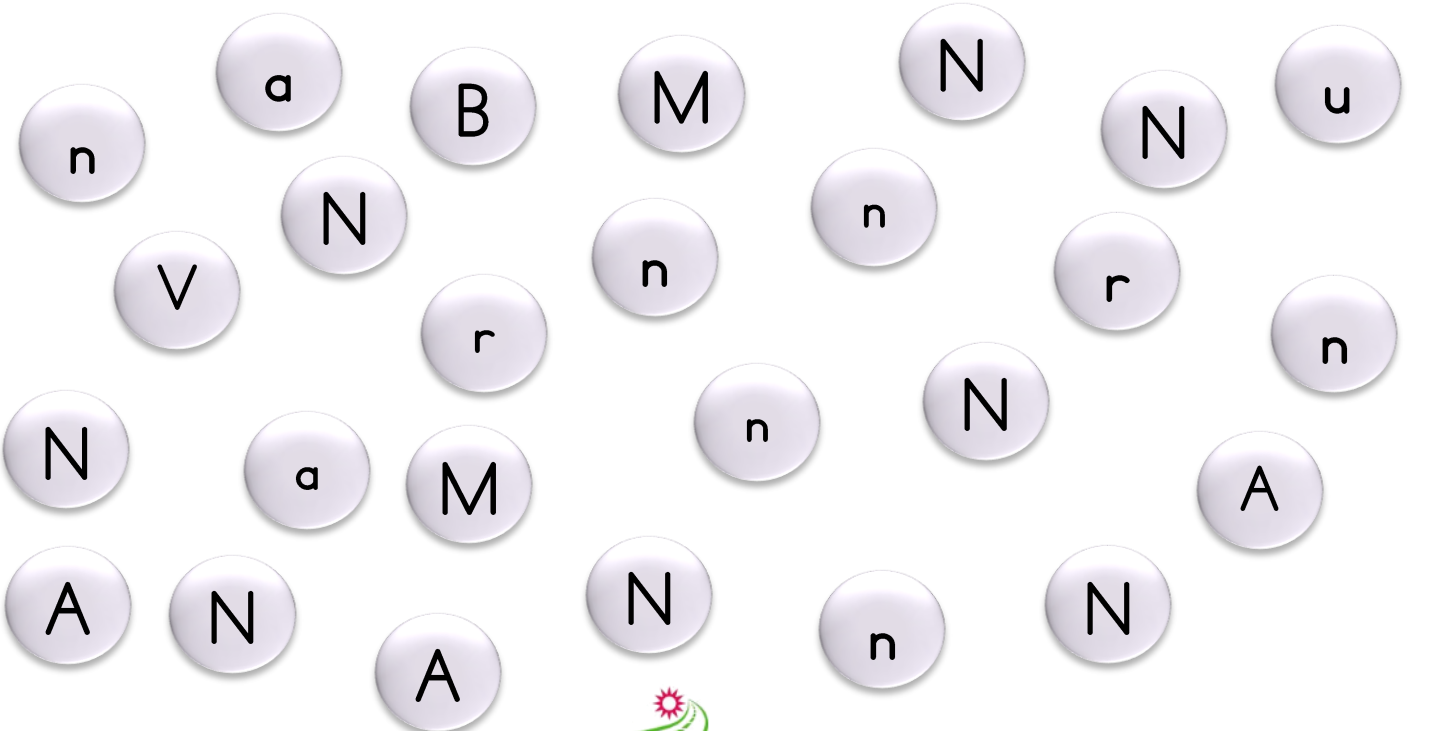

n

N



n n n n n n n n n n n n n n n n n n n n

n n n n n n n n n n n n n n n n n n n n

n n n n n n n n n n n n n n n n n n n n

n n n n n n n n n n n n n n n n n n n n

n n n n n n n n n n n n n n n n n n n n

n n n n n n n n n n n n n n n n n n n n

n n n n n n n n n n n n n n n n n n n n

n

n

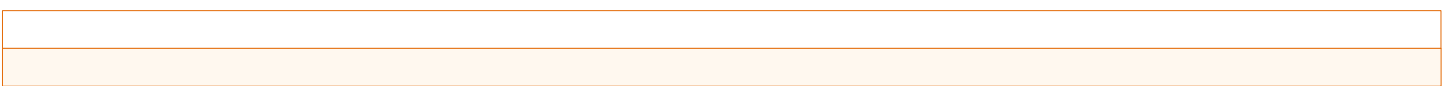
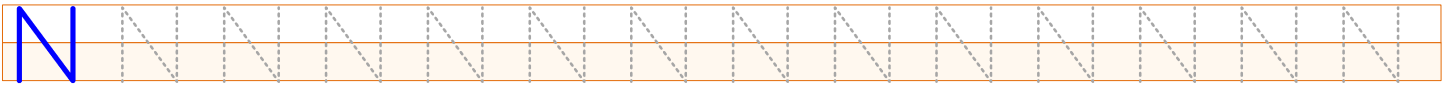
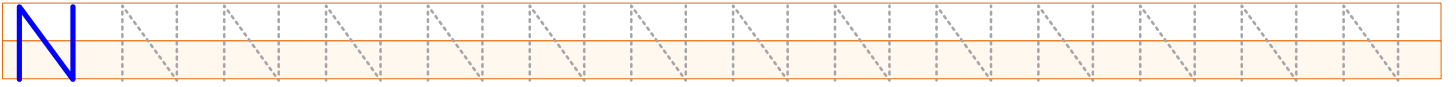
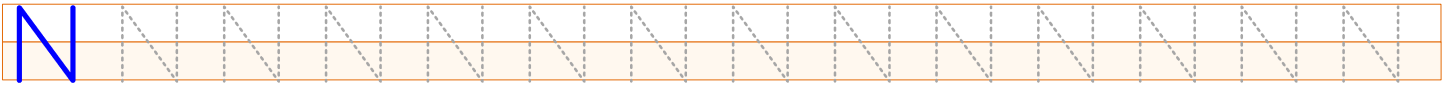
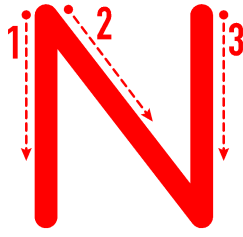

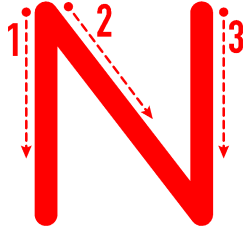

nn nn nn nn nn nn nn nn nn nn

nN

NnN

NnnN

nNnN

Görsellerin isimde kaç tane n-N sesi geçmektedir. İşaretleyiniz.



○○○



○○○



○○○



○○○



○○○



○○○



○○○



○○○

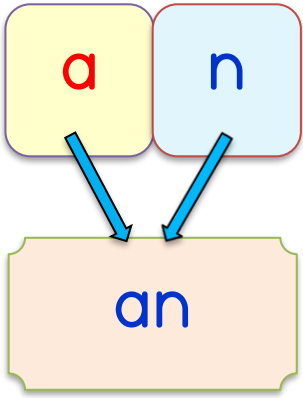

an an an an an an an an
an an an an an an an an
an an an an an an an an

an

an

an

an

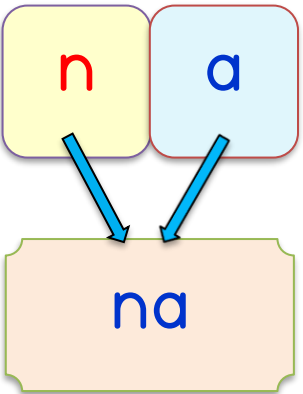

na na na na na na na
na na na na na na na
na na na na na na na

na

na

na

a na
ana



ana ana ana ana
ana ana ana ana
ana ana ana ana

ana

ana

ana

ana

na n
nan

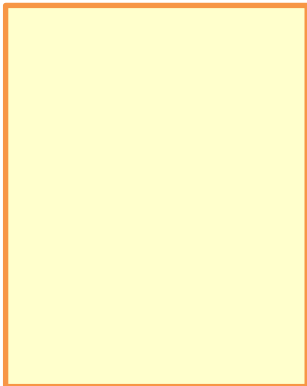

nan nan nan nan
nan nan nan nan
nan nan nan nan

nan

nan

nan

Ana an.

An ana an.

Aşağıdaki harfleri takip ederek çıkışa ulaşınız.

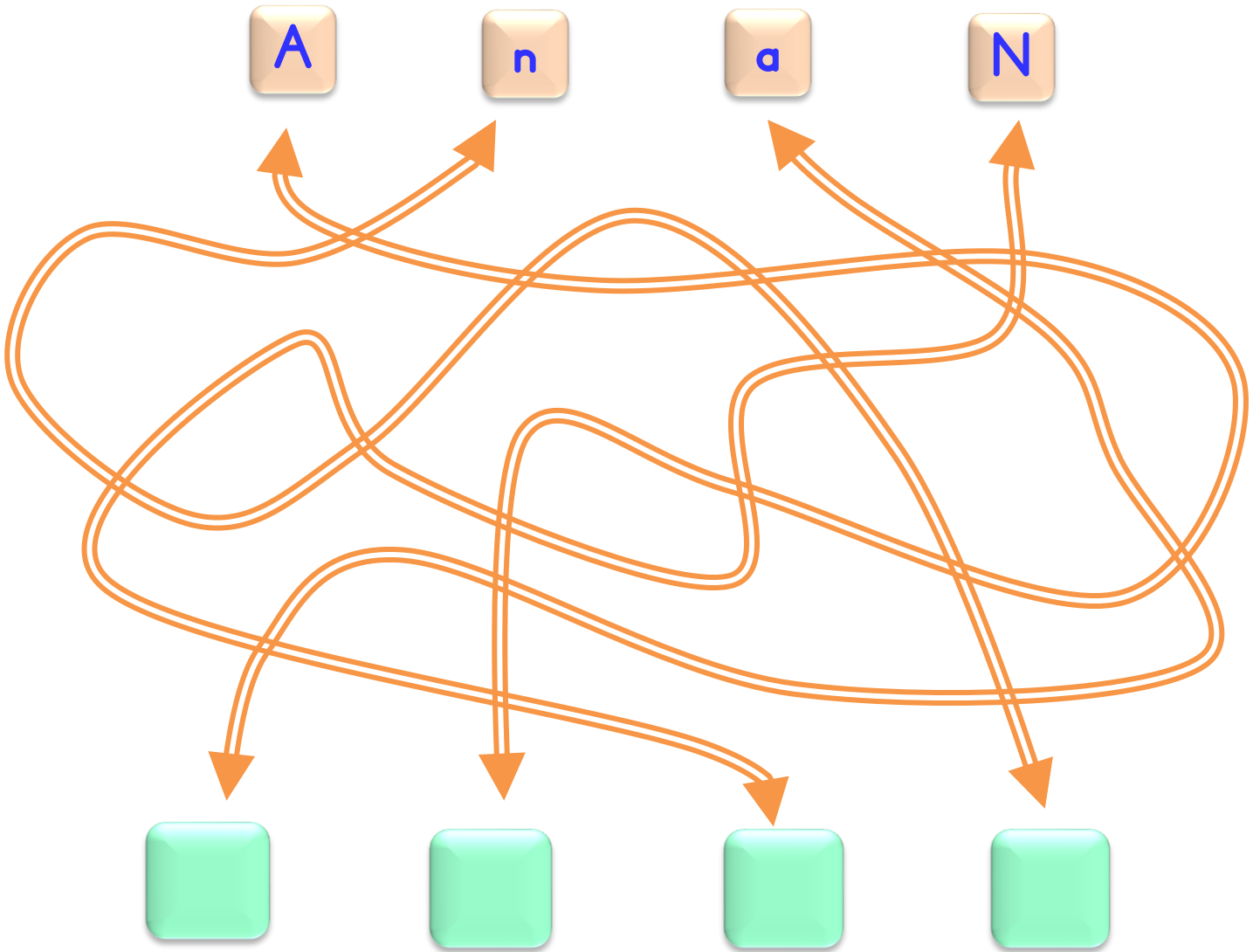

İçinde n sesi geçen nesnelere boyayınız.

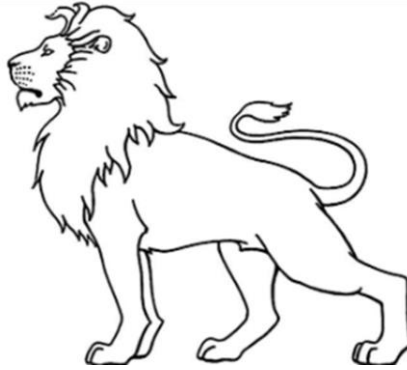
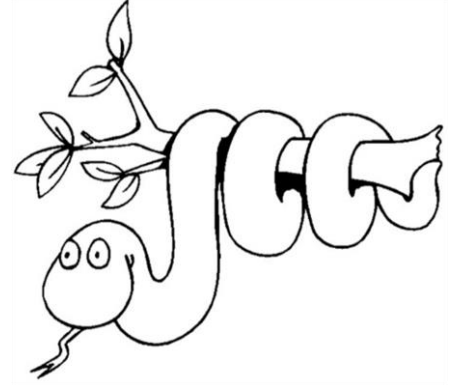
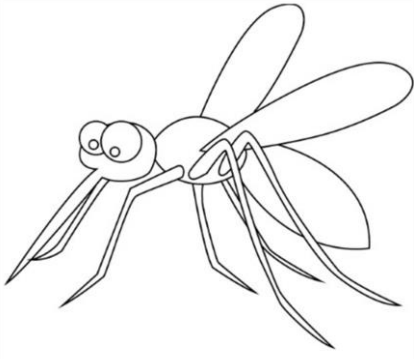

Papatyadaki harfleri gösterilen yönde sırası ile okuyup boyayınız.

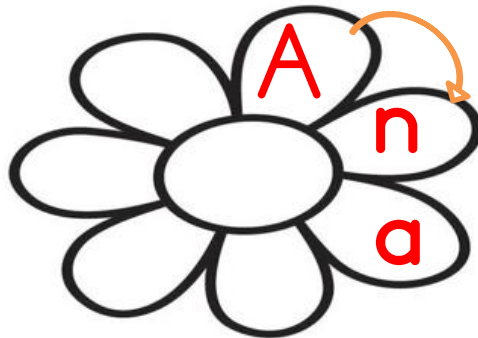
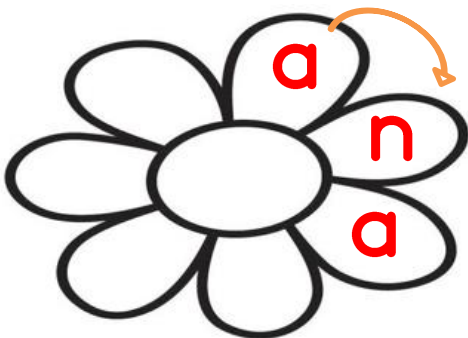
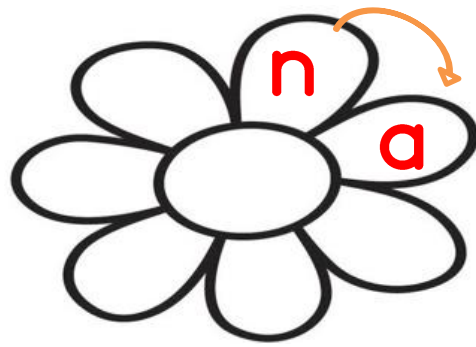
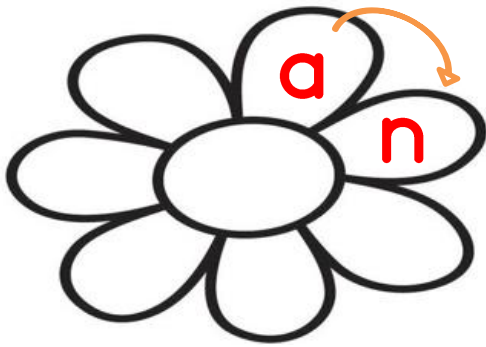

Boş bırakılan yerlere **n** harfini yazınız ve ismini söyleyiniz.



kavu...



Ay...a



iğ...e



i...ek



koyu...



ça...ta



i...cir



soğ...a



karı...ca



tre...



altı...



ayra...



gü...eş



kamyo...



yıla...



ma...tar



odu...



pey...ir



ye...geç



asla...