

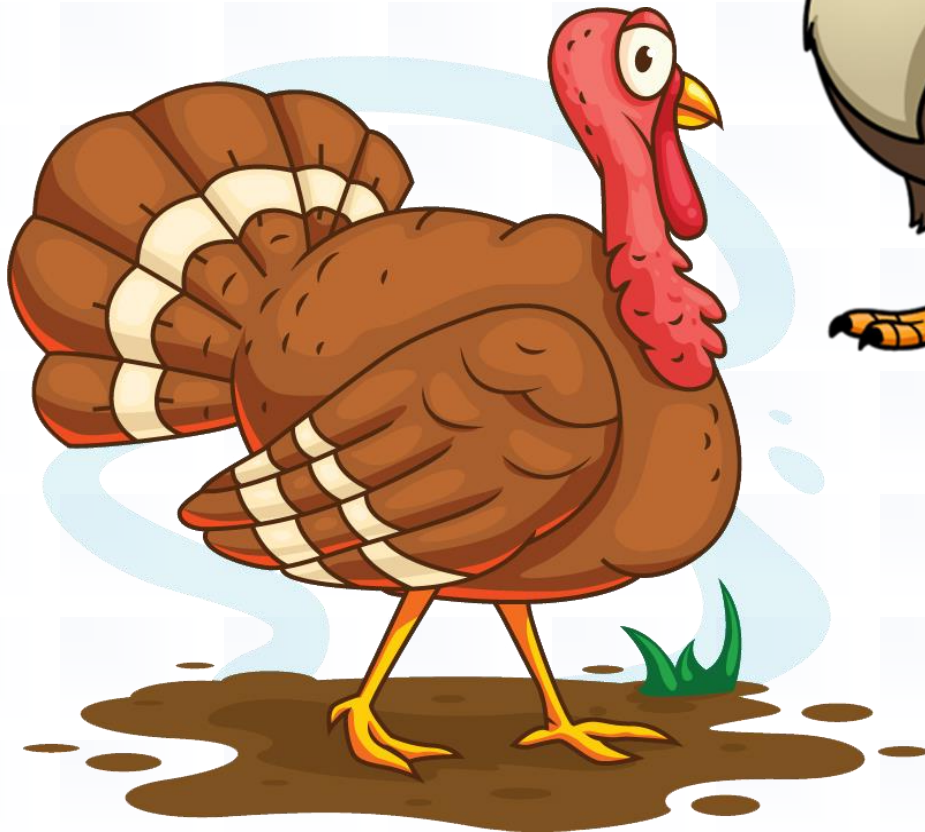

H h



Adı: .....  
Soyadı: .....

Türkçe  
İlk Okuma ve Yazma

H Harfi

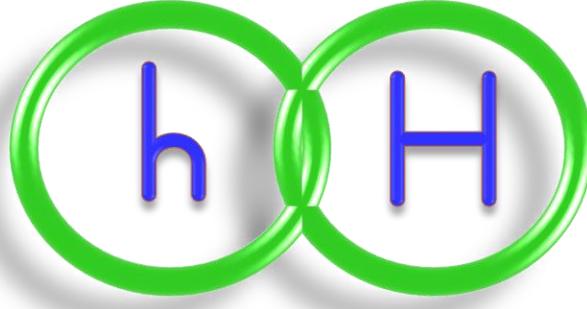

Aşağıdaki görsellerin isimlerini söyleyiniz.

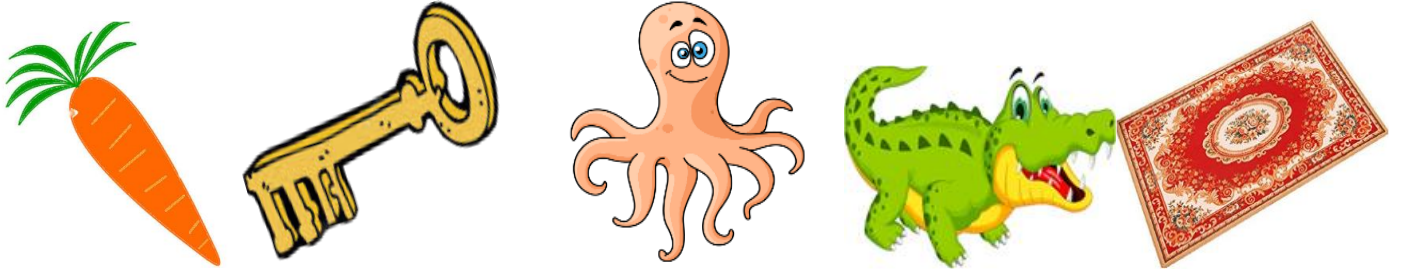

İçinde h sesi geçen görselleri işaretleyiniz.



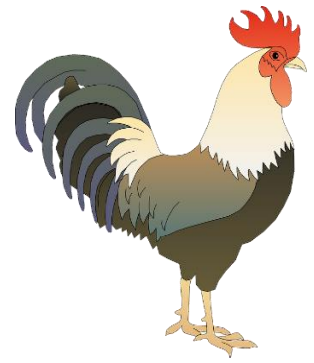
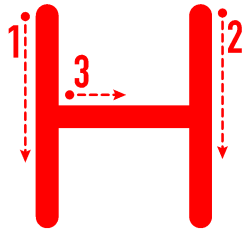
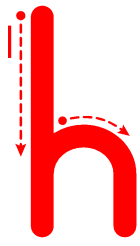

h h h h h h h h h h h h h h

h h h h h h h h h h h h h h

h h h h h h h h h h h h h h

h h h h h h h h h h h h h h

h h h h h h h h h h h h h h

h

h

h

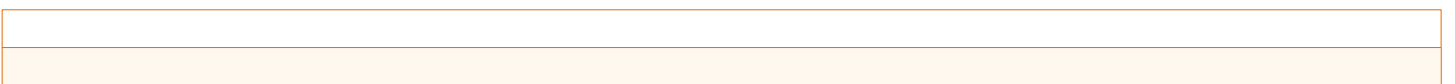
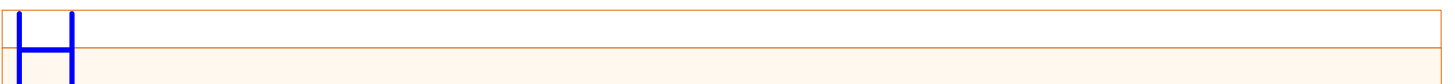
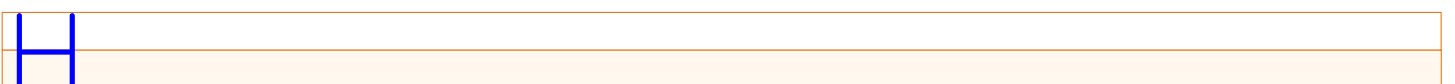
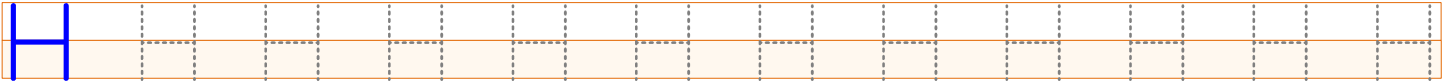
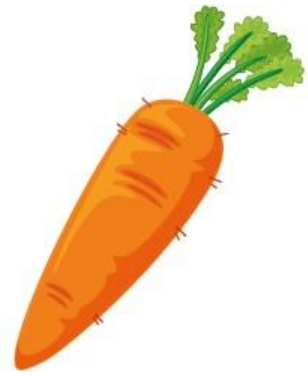
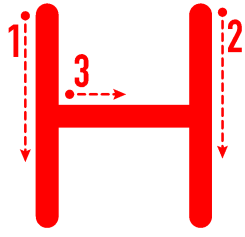
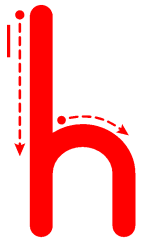

ah

eh

ih

ih

oh

öh

uh

üh

ha

he

hi

hi

ho

hö

hu

hü

ah eh ih ih oh öh uh üh

ha he hi hi ho hö hu hü

han hak hap hay hem hep her

hık hın hız hit hiç his hir

hoş hop hor hol hös höt hön

hut hun huk hüm hüt hüs hür

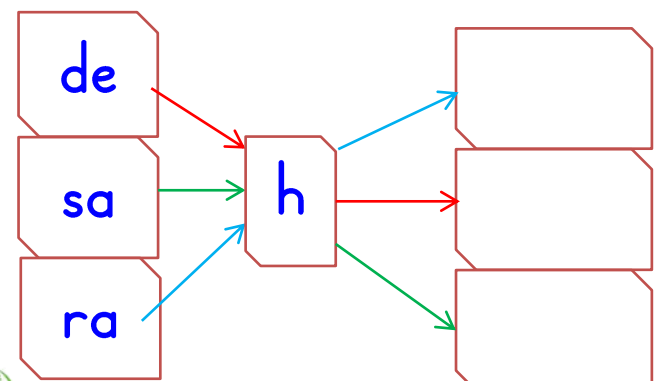
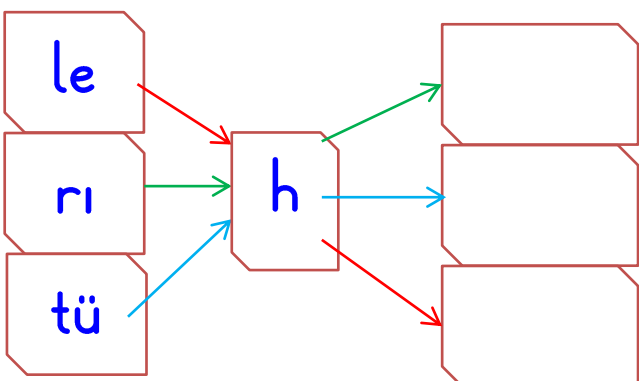
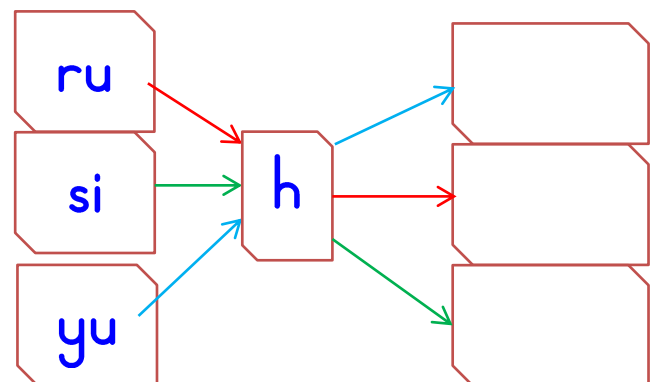
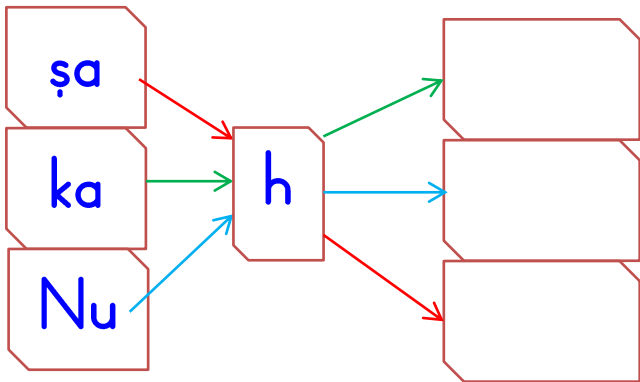

ha p

he m

hi ç

Ah met

Ah sen

Meh met

Hi lal

Ha kan

to hum

hor tum

ho roz

tim sah

Hül ya

he ce

hü cum

Rah man

ne hir

no hut

tes bih

hir ka

sa bah

hur ma

ba har

Ha san

ah ta pot

\_\_\_\_\_

has ta lık

\_\_\_\_\_

has ta ne

\_\_\_\_\_

ha ber ler

\_\_\_\_\_

Hü se yin

\_\_\_\_\_

ha zi ran

\_\_\_\_\_

ih la mur

\_\_\_\_\_

kah ka ha

\_\_\_\_\_

mü hen dis

\_\_\_\_\_

ha ri ta

\_\_\_\_\_

Mu ham met

\_\_\_\_\_

Ha ti ce

\_\_\_\_\_

hi ka ye

\_\_\_\_\_

haş lan ma

\_\_\_\_\_

la ha na

\_\_\_\_\_

ha zi ne

\_\_\_\_\_

hem şı re

\_\_\_\_\_

a nah tar

\_\_\_\_\_



Sözcükleri örnekteki gibi hecelere ayınız.

Ahmet

Ah met

Mehmet

halı

horoz

hindi

huzur

timsah

sabah

bahçe

hediye

ıhlamur

anahtar

kahkaha

ahtapot

hemşire

# HAYDİ

Hop hop hop oynayalım.  
Bahçede toplanalım.  
Haydi oyuna başlayalım.  
Henüz Hakan gelmedi.  
Bize topu atmalı.  
Gece olmadan yatmalı.



Ahsen bahçede top oynadı.

Ummahan hasta oldu, hap içti.

Harun her sabah hurma yer.

Hülya siyah hırkasını giydi.

## HEM

Hem Hülya hem Hatice  
Hava karardı, oldu gece  
Hem Ahmet hem Mehmet  
Hurmayı yemişler hayret.  
Hem Hale hem Helin  
İkisinin heykelini dakin.

## SİHİRBAZ

Bu halı sihirli halı  
Sihirli uçan halı  
Sihir yapmak zahmetli  
Külahta tavşan gitti.  
Haydi hokus pokus  
Biz bu sihirde yokuz.

## HASTA

Mehmet külah külah dondurma yedi. Hasta oldu. Hemen şehir hastanesine gitti. Doktor muayene etti. Hemşire şurup ve hap yazdı. Hasan sabah hapi yuttu. Annesi akşam ıhlamur yaptı. Hasan hapşırıldı durdu. Hap, hap, hapşu!



# HÜMA HEMŞİRE



Hüma Hanım her gün aynı işleri yapar. Sabah kalkıp hep ihlamur içer. Bahçesine gidip hindilere, horozlara, kuşlara hem yem atar hem de onlarla konuşur, sohbet ederdi.

Sonra işine giderdi. Hüma Hanım hemşireydi. Mahallemizdeki hastanede çalışırdı. Hep hasta olan kişilerle ilgilenirdi. Hiç yorulmadan onlara yardım ederdi. Hemşire Hüma Hanım bir hekim (doktor) olan Hamdi Bey ile çalışıyordu. Hekim Hamdi Bey hastaları muayene eder, hemşire Hüma Hanım da hastalarla ilgilenirdi.

Akşam olunca hemen evine dönerdi. Yemek yedikten sonra uykusu gelinceye kadar hikâye kitabını okurdu.



Hüma Hanım hangi işi yapıyor?

Hüma Hanım her sabah ne içer?

Hüma Hanım kimin yanında çalışıyor?

D  Y Hüma Hanım bir doktordur.

D  Y Hüma hanım her sabah çay içer.

D  Y Hüma Hanım tavuklarla sohbet eder.

D  Y O, Hamdi Bey ile çalışıyordu.

D  Y Hamdi Bey hastaları muayene eder.

D  Y O akşam olunca annesine gider.

D  Y O uyumadan önce hikaye okur.

# HOROZ

Bahçede bizim horoz,  
Hastalanmış biraz.  
Bahçede bizim hindi,  
Hop hop hopladı.  
Horozumuz hapi yuttu.  
Hastanenin yolunu tuttu.



İçinde **h** harfinin geçtiği görsellerin isimlerini yazınız.

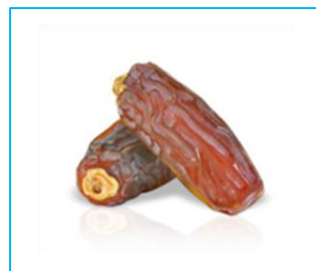
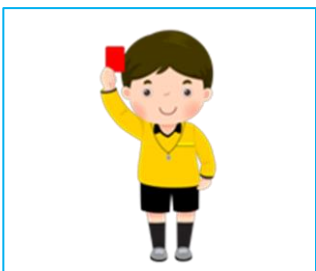
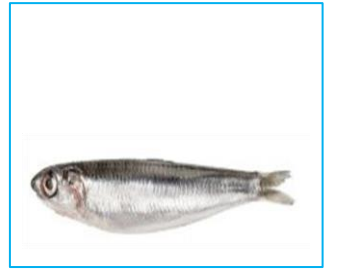
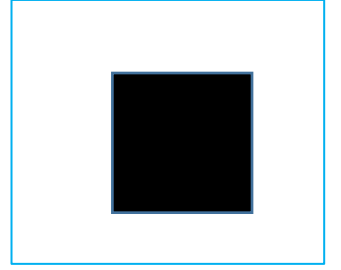
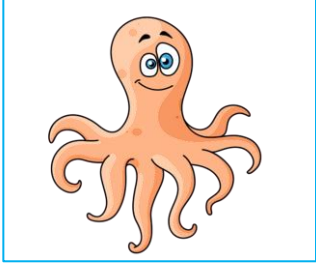

Hülya hastalanıp hastaneye gitti.

Hiç hamsi haşladın mı?

Ahmet kitap okurken ihlamur içti.

Timsah çok tehlikeli sürüngendir.

Mehmet, Seher'e halı hediye etti.

Hırsız hızlı hızlı kaçıyordu.

Hale her gün hortumla çiçek sular.



ah	eh	ih	ih	oh	öh	uh	üh
ha	he	hi	hi	ho	hö	hu	hü
han	hen	hin	hin	hon	hön	hun	hün
hat	het	hit	hit	hot	höt	hut	hüt
hal	hel	hil	hil	hol	höl	hul	hül
hak	hek	hik	hik	hok	hök	huk	hük
har	her	hir	hir	hor	hör	hur	hür
ham	hem	him	him	hom	höm	hum	hüm
has	hes	his	his	hos	hös	hus	hüs
hay	hey	hiy	hiy	hoy	höy	huy	hüy
haz	hez	hız	hiz	hoz	höz	huz	hüz
hap	hep	hip	hip	hop	höp	hup	hüp
haç	heç	hiç	hiç	hoç	höç	huç	hüç
hah	heh	hih	hih	hoh	höh	huh	hüh
hag	heg	hig	hig	hog	hög	hug	hüg
hac	hec	hic	hic	hoc	hök	huc	hüc
haş	heş	hiş	hiş	hoş	höş	huş	hüş