



Adı Soyadı :

Numarası :

Konu: Hece ve Kelime Çalışması Etkinliği

Aşağıda karışık olarak verilmiş olan hecelerle kelimeler oluşturalım.

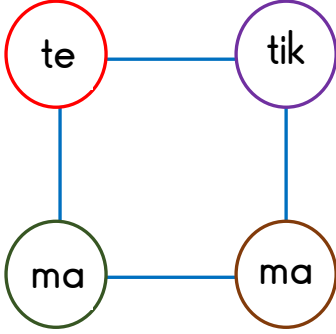

matematik

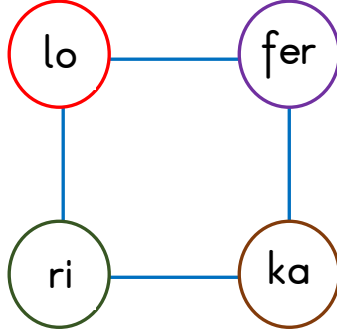

.....

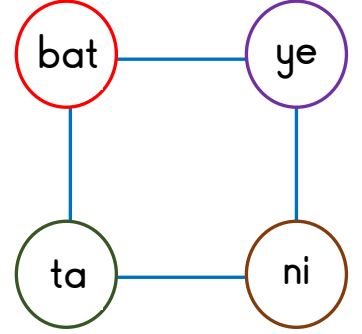

.....

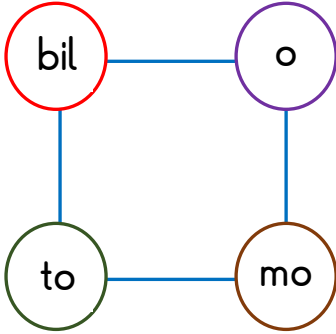

.....

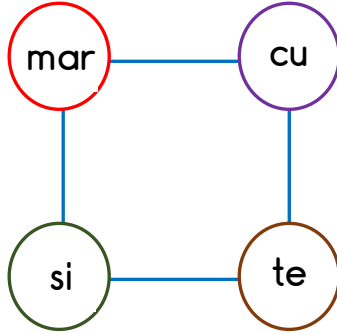

.....

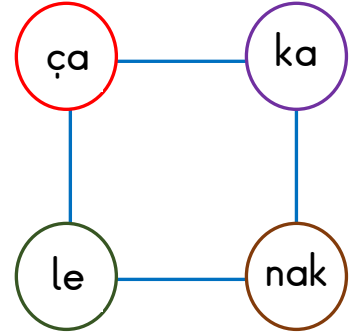

.....

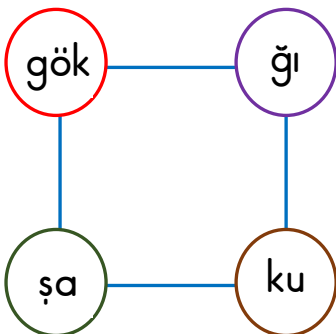

.....

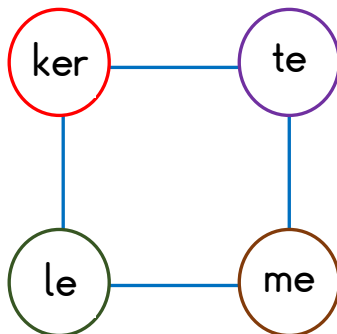

.....

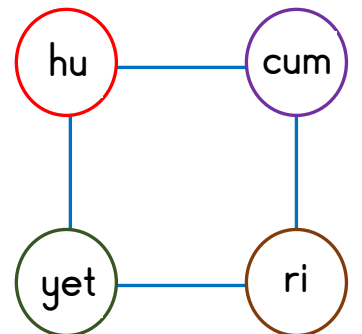

.....

Aşağıda verilen sözcüklerin hece sayılarını bulunuz. Örnekteki gibi sıra numarasına göre hece sayısını uygun bölüme yazınız.

1 gömlek

2 kaplumbağa

3 araba

4 yol

5 pijama

6 okul

7 mart

8 salatalık

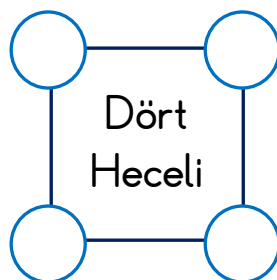
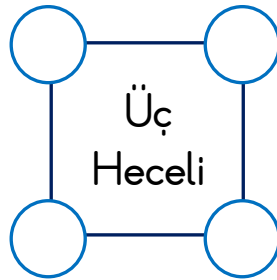
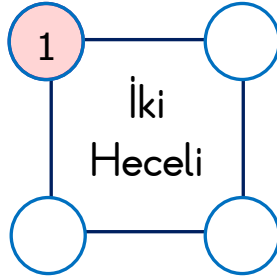
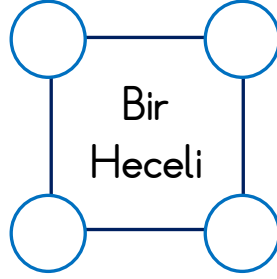

9 bal

10 kertenkele

11 sınıf

12 gazete

13 kütüphane

14 oyuncak

15 uç

16 lastik